



bluparts
produtos automotivos

Abril 2024

CADERNO DE DESTAQUES E LANÇAMENTOS



**Robust
Gedore**

**Jogo Oficina
Master
c/. 178 peças**

13060370



PRODUTOS

bluparts
produtos automotivos



Mini Graxa HBS 2.0 Mini Limpa contatos



040027/12



Grátis
NA COMPRA
DA CAIXA C/12



040010/12



Grátis
NA COMPRA
DA CAIXA C/12



040011/12

PRODUTOS



LIMPADOR DISCOS FREIOS E COMPARTIMENTO CORREIAS

ESPUMA BLU Multiclean

Limpeza sistemas de freio
Embreagem e
Compartimento da correia dentada



040069





LIMPA FREIOS



LIMPA DISCOS
DE FREIOS E
PINÇAS DE FREIO
500 ML

040034

PRODUTOS



DESCARBONIZANTES

BLU DIC e FLEX Perfec Clean 500 ml



040119



Preço especial
(NA CAIXA C/12)



040119-12
040122-12



040122

PRODUTOS



ADITIVOS RADIADORES



66040106
BLU FLUID
PRONTO USO
24 X 1 LITROS



ADITIVO RADIADOR COMBAT
66040100 AZUL
66040100V VERDE
66040101 ROSA



ADITIVO CONCENTRADO
TECNOLOGIA
HÍBRIDA*

66040103



ADITIVO CONCENTRADO
TECNOLOGIA
HÍBRIDA

***NA CAIXA COM 24 LITROS**

66040102



TAMBÉM DISPONÍVEL
EM TAMBOR DE 200 L
PRONTO USO CORES
04003-200 ROSA
04003-200V VERDE

TAMBÉM DISPONÍVEL
EM TAMBOR DE 200 L
CONCENTRADO CORES
04002-200 ROSA
04002-200V VERDE



ÁGUA DESMINERALIZADA

PARA RADIADORES...



E BATERIAS



05H201

PRODUTOS

bluparts

produtos automotivos

SPRAY'S GERAL



SPRAY 500ml



040027/12

040027

DESINGRIPANTE



BLULUB 300ml



040010/12

040010



HIGIENIZADOR DE AR CONDICIONADO granada



040062/12 LAVANDA
040063/12 CARRO NOVO
040064/12 SUMMER
040066/12 MIX (MISTO)
040068/12 CLASIC



HIGIENIZADOR DE AR CONDICIONADO p/vaporização



040060/24 CARRO NOVO
040060/124 LAVANDA
040060/224 CLASSIC
040060/324 SUMMER



LIMPA VIDROS



040026/24

PASTA GEL LIMPEZA DE MÃOS



050377

GRAXA ALTA ADERÊNCIA

* RESISTE A ÁGUA
* ALTAS TEMPERATURAS



040015/12

040015

BLU SILICONE SPRAY



040011/12

040011

PRODUTOS

bluparts
produtos automotivos

SPRAY'S GERAL

- * MULTI USO
- * USO NAUTICO
- * USO AUTOMOTIVO
- * ALTA PERFORMANCE



GRAXA BRANCA



040030

040030/12

LIMPA CONTATOS ELÉTRICOS

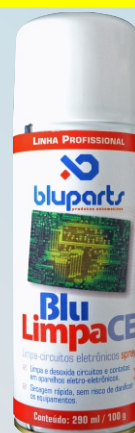

040013

040013/12

GRAFITE

LUBRIFICA A SECO

- * FECHADURAS
- * CANALETAS PORTAS
- * ANTENAS



040012



ANTI-CHIOS



ANTI CHIOS
ELIMINA RUIDOS
DAS PASTILHAS

040035

PROTETOR DOS POLOS DA BATERIA



040032

mini DESINGRIPANTE 65ml

- * LUBRIFICANTE
- * REPELE UMIDADE
- * ANTI-FERRUGEM



040150

SILICONE SPRAY mini

- * LUBRIFICA A SECO
- * DA BRILHO

65ml

040151



GRAXA ALTA ADERÊNCIA

mini

- * RESISTE A ÁGUA
- * ALTAS TEMPERATURAS

65ml

040155



NOVIDADES



0530022

MK-66 é um lubrificante sintético especialmente desenvolvido para corrente de Motos e Karts. Em forma de fluido, penetra dentro das articulações da corrente, deixando um filme aderente e resistente, diminuindo consideravelmente o desgaste. Resistente a água, altas rotações e a altas temperaturas.

LANÇAMENTOS



0530053

Lubrificante seco à base de PTFE, para aplicação em locais que exigem uma lubrificação livre de umidade.
(Uso geral, não só para correntes)



0530038

Graxa à base cobre para montagens de parafusos, porcas e prisioneiro que trabalham em altas temperaturas.



0510351

Graxa especial para rolamento da bike 250 g.
Não contém Lítio 100% sintética
Alta concentração PTFE



13EPP386557 P
13EPP386458 M
13EPP386459 G
13EPP3864510 GG

CA 38.645

PARA TIRAR CHIO DE PASTILHAS DE FREIOS



Rolo de
50mm x 20 m

05131951

SILICONE ALTA TEMPERATURA NEOKLON NEUTO PRETO
Cola 100% Silicone sem Cheiro Alta Temperatura de 265°C Neuto Preta para Juntas de Motor, Câter, Escapamentos, Radiadores Bombas d'Água Neoklon 50g



0521502

SILICONE ALTA TEMPERATURA NEOKLON NEUTO CINZA
Cola 100% Silicone sem Cheiro Alta Temperatura de 265°C Neuto Preta para Juntas de Motor, Câter, Escapamentos, Radiadores Bombas d'Água Neoklon 50g



05200501

PRODUTOS QUÍMICOS

FILME PARA VOLANTE

R\$ 467,64

(R\$ 12,99 CADA
NA CAIXA C/36)

AVULSO R\$ 14,99 CADA
ECONOMIZE R\$ 72,00 POR CAIXA



66056483

SELANTES ADESIVOS TRAVAS QUÍMICAS

SILICONE ALTA TEMPERATURA



MAXX BLACK 80G

05215085



MAXX GRAY 80G

05200851

TRAVA QUÍMICA TORQUE (GENÉRICO LOCTITE)



057110 057150
Alto



054110 054150
Medio



0551850
Elimina Juntas

ADESIVO INSTANTANEO 20G



0549520



R\$ 10,99

COLA PARA-BRISAS (Primer Less)



6605201

COLAS DE PARABRISAS LOCTITE



059092

(Primer Less)

VEDANTE PARA CARROCERIAS

CINZA (05227)

BRANCO (05227W)

PRETO (05227B)



COLA BRANCA SEMI SECATIVA 100G



051114

PRODUTOS QUÍMICOS



040069

ESPUMA BLU Multiclean

Limpeza sistemas de freio
Embreagem e
Compartimento da correia dentada



ESPUMAS DE LIMPEZA

ESPUMA LIMPA TUDO, 400 ML



040087

Fácil e simples de usar,
com poderoso efeito de limpeza.
Sem enxague e não escorre.
Indicada para limpeza à seco,
de ação rápida e eficiente.
Ideal para limpar os mais diversos
tipos de superfícies laváveis tais
como o interior dos carros,
carpetes, estofados, paredes,
plásticos, vinil e formica.

PRODUTOS



Limpeza e conservação



SELANTE PARA RADIADOR

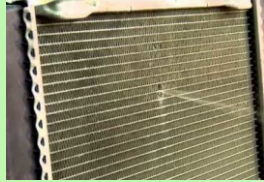

040029

040029/24

CRISTALIZADOR DE VIDROS



100ml



040024



ANTIEMBAÇANTE DE VIDROS



040033

LAVA AUTOS



500ml
040025



LIMPA PNEUS GEL



200ml

040018

ADITIVO ÓLEO MOTOR



- * MOTOR CANSADO
- * GASTANDO ÓLEO

040017



ADITIVO ÓLEO MOTOR PROTETIVO

- * REDUZ ATRITO
- * PROLONGA A VIDA DO MOTOR

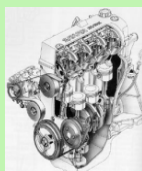

040016

ESPUMA BLU Multiclean

Limpeza sistemas de freio
Embreagem e
Compartimento da correia dentada

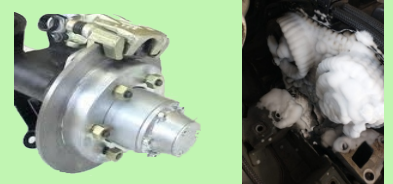

040069

PEÇAS

Kit Teste para Arla 32 10 ml



O kit teste para arla de 10 ml é ideal para a avaliação do Arla 32, identificando a presença de elementos contaminantes que podem prejudicar o sistema de pós-tratamento dos gases do veículo.

1332CK-ARLA

DIVERSAS

ABRAÇADEIRA UNIVERSAL DE COIFAS

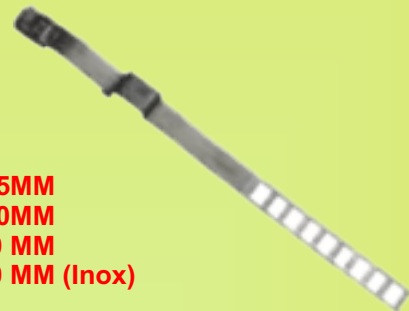

181022 25,5 Á 55MM
181023 60 Á 90MM
181024 85 Á 130 MM
181027 85 Á 130 MM (Inox)

CINTA PLÁSTICA



CINTA PLÁSTICA
20 cm
33200

CINTA PLÁSTICA
28 cm
33280

Pacote c/. 200

CONTRA PESO COLANTE 5/10G AÇO

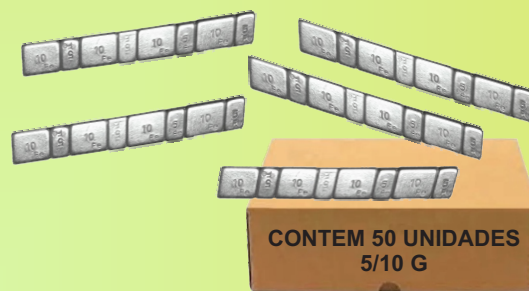

CONTEM 50 UNIDADES
5/10 G

1006260

ABRAÇADEIRA NORMA



ABRAÇADEIRA NORMA
MANG. COMBUSTIVEL 10X12MM
15011



ABRAÇADEIRA NORMA
MANG. COMBUSTIVEL 12X14MM
15013

TERMINAL BATERIA SAPINHO TERMINAL BATERIA SAPÃO



TERMINAL BATERIA
SAPINHO
33TB05



TERMINAL BATERIA
SAPÃO
33TB06

dni
automotive

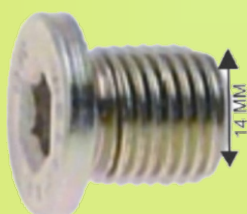

2719340

BUJAO CARTER GOL/ PARATI/ SAVEIRO/ POLO/
CROSSFOX M14X1,5 CHAVE 8MM 14X1,5 X 13MM

25VK4TV

KIT ROLAMENTO ROLETES CÔNICOS
CARGA RADIAL/AXIALRODA
TRASEIRA FORD:VERSAILLES >97,
VW:GOL 80>97,SAVEIRO,SANTANA



VETOR
AUTOMOTIVOS

Rolamento

VETOR
Graxa para
Rolamentos
AUTOMOTIVOS VGR-1
Conteúdo: 40g

PEÇAS

DIVERSAS

COXIM ESCAPE



(02303)

COXIM TRASEIRO DO SILENCIOSO
PASSAT / GOL / VOYAGE / PARATI



(02304)

COXIM DIANTEIRO DO SILENCIOSO
GOL 80/... PARATI 81/... PASSAT 74/89
SANTANA 84/... SAVEIRO 82/... VOYAGE 81/...



(02350)

COXIM CENTRAL DO SILENCIOSO
GOL 84/84 - LOGUS 82/86 - PARATI 88/91
PUNTER 82/86 - SANTANA 84/... - VOYAGE 86/91



02100
ANEL DO SILENCIOSO
KADETT - MARAJÓ - MONZA - OPALA

Pacote c/.10

COXIM DO RADIADOR



COXIM DO RADIADOR GRANDE
GOL 80/... PARATI 81/... PASSAT 74/89 - SANTANA 84/...
SAVEIRO 82/... - VOYAGE 81/85

02323

COXIM DO RADIADOR PEQUENO
SAVEIRO 82/... - VOYAGE 81/85

GOL 80/... - PARATI 81/... - PASSAT 74/89 - SANTANA 84/...

02322



BUCHA BANDEJA SUSP. DIANTEIRA



02324

Cod. Orig: 811.407.181-A
BUCHA DA BANDEJA SUSP. DIANTEIRA
GOL 88/... - PARATI 86/... - SAVEIRO 87/...
SANTANA 84/80 - VOYAGE 88/85



02320

Cod. Orig: ZBC-407.181
BUCHA DA BANDEJA SUSP. DIANTEIRA
GOL 80/87 - PARATI 91/95 - PASSAT 83/89
SAVEIRO 82/86 - VOYAGE 81/87

KIT COXIM AMORTEC. DIANTEIRO



KIT COXIM AMORT. DIANTEIRO
GOL / PARATI 86-87 / SANTANA 86/...

021024



KIT COXIM AMORT. DIANTEIRO
GOL / PARATI 87 - 83

6602101046



KIT COXIM AMORT. DIANTEIRO
GOL LINHA 8X / 84

021016

KIT ESTABILIZADOR



KIT ESTABILIZADOR
UNO MILLE INTERNO AZUL
66022012



KIT ESTABILIZADOR
UNO / PREMIO / ELBA 81... EXTERNO
66022013



KIT ESTABILIZADOR
UNO / PREMIO / ELBA 81... INTERNO VERMELHO
66022010

KIT ESTABILIZADOR



KIT ESTABILIZADOR
GOL/VOYAGE
EXTERNO 15MM
66021005



KIT ESTABILIZADOR
GOL/VOYAGE
INTERNO 15MM
66021004

KIT TRAMBULADOR



JOGO BUCHAS TRAMBULADOR
C/ COIFAS 4 MARCHAS
51101806



JOGO BUCHAS TRAMBULADOR
C/ COIFAS 5 MARCHAS
51101807



KIT TRAMBULADOR CORSA
1.0/1.4/1.6 C/ LIAME
614037

REPARO SEMI EIXO



REPARO SEMI EIXO COMPLETO
FUSCA / BRASLIA
021039



REPARO SEMI EIXO LADO CÂMBIO s/ROLAMENTO
UNO / ELBA / PREMIO 81/85

022505



REPARO SEMI EIXO LADO CÂMBIO
PALIO 1.0 / 1.5 16V / TIPO 1.6 / UNO 86/...
022506

PEÇAS

DIVERSAS

PALHETA LIMPADORA ISOFLEX



80PLH2216F51
80PLH2216F55
80PLH2415F54
80PLH2118F55
80PLH2416F51
80PLF2624F52
80PLH2416F52
80PLH2415F55
80PLH2119F51
80PLH2115F54
80PLH2218F55
80PLH2414F55
80PLH2419F52
80PLH2615F54
80PLH2415F52

22/16" VW GOL G6/SAVEIRO 13/..
22/16" ECOSPORT II13>.../ KA
24/15" IDEA/ADVENTURE/UNO
21/18" M AGILE 11/-MONTANA 11/
24/16" VW UP 14/..
26/24" HONDA CIVIC 2006/
24/16" FIAT 500 09/ PALIO12/
24/15" IDEA/ ADVENTURE 11>14
21/19" VW POLO 13/..
21/15" FORD FIESTA/ SEDAN
22/18" GM TRAILBLASER/S-10 13/..
24/14" GM ONIX/PRISMA 13/..
24/19" VW/FIAT
26/15" FIAT LINEA / PUNTO
24/15" HONDA CITY2010/...

PALHETA ISOFLEX HIBRIDA "GANCHO"

80PLH2216FLH 22/16" TOYOTA HILUX 15>..CHERY FACE 10>...
80PLH2218FLH 22/18" MITSUBISHI L200 TRITON 08>16
80PLH2416FLH 24/16" HB-20 / I30 13 / RENAULT KICKS 16>...
80PLH2614FLH 26/14" PRIUS 14>./ COROLLA / HAV-4 15> HRV / RAV-4 15>...
80PLH2616FLH 26/16" COROLLA 08>14 / SUBARU FORESTER 12>...
80PLH2623PLH 26/23" HONDA CIVIC 12>...



CHICOTE INSTALAÇÃO DE SOM



33TC0834

CHICOTE INSTALAÇÃO DE SOM
VW / GM / FIAT 12 VIAS - 2x8 VIAS

CHICOTE INSTALAÇÃO DE SOM
DIVERSOS 12 VIAS - 16 VIAS



33TC0802

GRAXA GRAFITADA BISNAGA 80G



051180

GRAXA AZUL BISNAGA 80G



05125480

GRAXA BRANCA BISNAGA 80G



0541080

PRODUTOS

MALETAS BLUPARTS

CAIXA GRAMPOS PARABARRO 91P001KIT



230 GRAMPOS PARA-BARRO E VÃO DE RODAS CONTENDO:

5135732	50
911571409	20
91P16K	20
91P121	20
91P184	15
911550129Z	15
91P171	10
91P183	20
91P234	15
91P355	10
91P251	20
91P284	15



CAIXA DE BUJÕES E ANEIS DE VEDAÇÃO CARTER

CAIXA COM 51 BUJÕES DE CARTER E 105 ANEIS DE VEDAÇÃO CARTER
DOS PRINCIPAIS MARCAS DE VEICULOS

CÓDIGO 27CX001



MALETA PLÁSTICA ABRAÇADEIRAS BLUPARTS CÓDIGO 15KIT02



COMPOSIÇÃO DA MALETA:

- 01- MALETA PLÁSTICA 48CMX37,5CMX7,5CM
- 110- ABRAÇADEIRAS DE 9MM
- 9X13 ATÉ 57X70 10 DE CADA TAMANHO
- 40- ABRAÇADEIRAS 14 MM
- 13X19 E 19X27=10 DE CADA
- 22X32-25X38-38X51-51X64=05 DE CADA
- 01- CHAVE CANHÃO 6MM
- 01- CHAVE CANHÃO 7MM
- 01- CHAVE DE FENDA 3/16X5'

PRODUTOS

MALETAS BLUPARTS

CAIXA PLASTICA COM REBITES DE REPUXO

5401
CAIXA COM 550 REBITES
REPUXO
E REBITADEIRA KING TONY



5401AB
CAIXA COM 550 REBITES
REPUXO ABA LARGA
E REBITADEIRA KING TONY

PRODUTOS

KIT COIFAS

021500 LADO RODA
GOL/PARATI/VOYGE/SANT 1.6/1.8

20



021504
LADO RODA GOL/PARATI
96/...

25



022500 LADO RODA
UNO/PREMIO/ELBA

20



024501 LADO RODA
CORSA TODOS

20



020041 LADO RODA
PALIO - SIENA - WEEKEND 01/
DOBLO 1.3-1.6

15



66022100

***GRÁTIS 05 CESTOS EXPOSITORES**

PROMOÇÕES



LAMPADAS WEDGE
(LARANJA)
BASE DE VIDRO
1 E 2 POLOS HBL



336941AMB



336942AMB

HBL H7 12V
*PARA PACOTE C/10
Homologada Inmetro



6633H7

LÂMPADAS HBL

HBL H4 12V *PARA PACOTE C/10
Homologada Inmetro



6633H724

HBL H4 12V
*PARA PACOTE C/10
Homologada Inmetro



6633H4

lâmpadas 2 polos 12v



66331034

LÂMPADAS HBL

LAMPADAS AUTOMOTIVAS

EMBALAGEM C/10



lâmpadas 1 plos 12v



66331141

lâmpadas pingão 12v 3 w



66332821

LÂMPADAS HBL

LAMPADAS AUTOMOTIVAS

EMBALAGEM C/10



lâmpadas pingão 12v 5 w



66332825

PEÇAS

LANÇAMENTO

Abraçadeira Fixação para Bordas,
conjunto 2 peças clip + abraçadeira

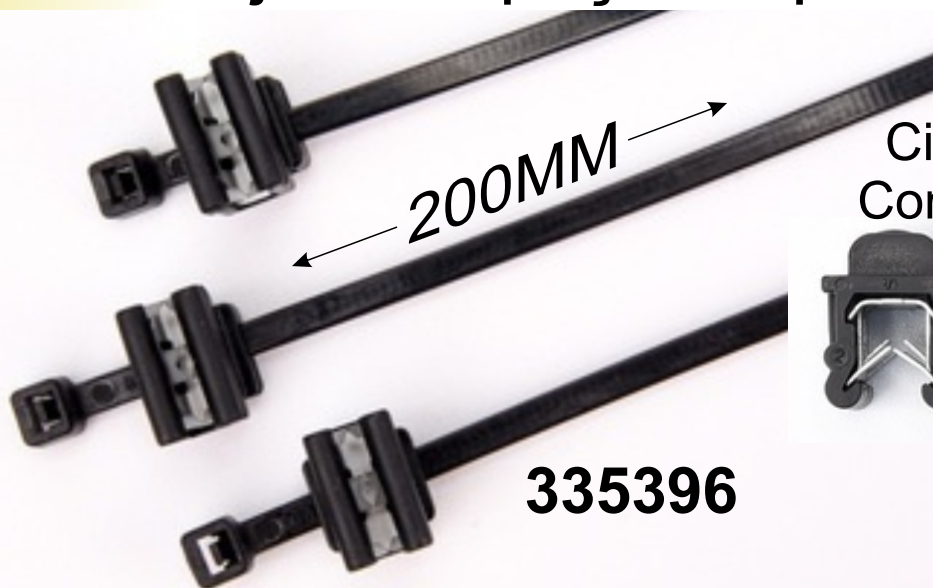

Cinta plastica 200 mm
Com clip Edge, 3 a 6mm



335396



Cinta Plastica de 200 mm
Com clip Edge , 1 a 3mm

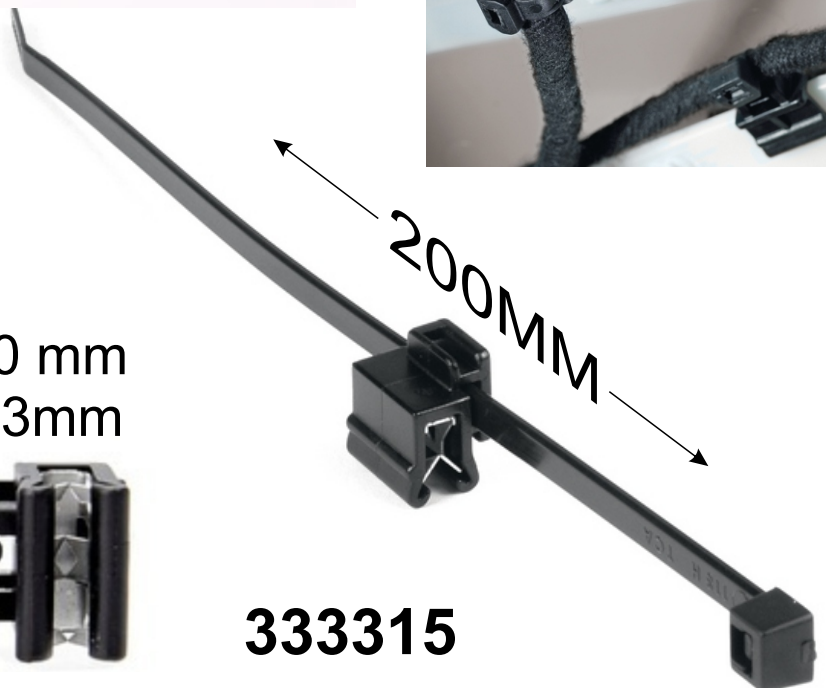

333315

(Ambas embalagem C/ 20 peças)

PRODUTOS

LANÇAMENTO

Código 13C02



CARRINHO SIGMA DETAILERS (Plástico)

**VALIDO EM QUANTO DURAR O ESTOQUE
(SOMENTE 03 UNIDADES NESTA PROMOÇÃO)**

PROMOÇÕES



OPCIONAL
13RJ2212
ADAPTADOR PARA BICOS HONDA GDI
KIT PARA 4 BICOS

13RJ100GDI

PROMOÇÃO

R\$ 3299,99** (Prazo do sistema)

(ou 6x no cartão de credito
Valor final R\$ 3.299,99)

***solicite o link de pagamento**

**Válido até 17/06, 03 maquinas disponíveis

Equipamento com tecnologia de autorreconhecimento de injetores de injeção indireta (Convencional) e injeção direta (GDI), dispensa a utilização de funções para cada tipo de injetor, proporcionando praticidade em sua utilização. Além de funções para bisco injetores, possui funções específicas para teste de motores de passo, atuadores de marcha lenta, corpo de borboleta e pedal eletrônico.

* Enviaremos o link do Mercado pago pelo Whats

NOVIDADES

LANÇAMENTO

Auxiliar de partida 800 amperes



13APF-800A

APLICAÇÃO: VEÍCULOS 12 VOLTS
CORRENTE DE PARTIDA PICO (CCA): 800A
CORRENTE DE PARTIDA NOMINAL: 400A
CORRENTE DE PICO SIMILIAR: BATERIA 100A.
BATERIA INTERNA: 10.000 mAh / 37WH
RECARGA: VIA USB 5V/1,5A
SAÍDA USB: 5V/2.1A
TAM.: A: 25 mm L: 85 mm C: 150 mm / PESO: 430 g

13APF-600A

APLICAÇÃO: VEÍCULOS 12 VOLTS
CORRENTE DE PARTIDA PICO (CCA): 600A
CORRENTE DE PARTIDA NOMINAL: 300A
CORRENTE DE PICO SIMILIAR: BATERIA 50A.
BATERIA INTERNA: 7200 mAh / 26,64WH
RECARGA: VIA USB 5V/1,5A
SAÍDA USB: 5V/2,1A
TAM.: A: 25 mm L: 85 mm C: 140 mm /
PESO: 320 g



13APF-1200A

APLICAÇÃO: VEÍCULOS 12 VOLTS
CORRENTE DE PARTIDA PICO (CCA): 1200A
CORRENTE DE PARTIDA NOMINAL: 600A
CORRENTE DE PICO SIMILIAR: BATERIA 180A.
BATERIA INTERNA: 16.000 mAh / 59,2WH
RECARGA: VIA USB 5V/2A
SAÍDA USB: 5V/3A, 9V/2A, 12V/1.5A
TAM.: A: 35 mm L: 100 mm C: 195 mm / PESO: 770 g

NOVIDADES

LANÇAMENTO



**13CR500
SUSTENTADOR DE
MOTOR
COM REGULAGEM
E 2 GANCHOS**

NOVIDADES

LANÇAMENTO

13IJ-21103



Motores Fiat / Stellantis GSE 1.0 12V
(3 cils.) MultiAir turbo T200
aplicados nos Fiat Pulse (21>) e
Fastback (22>) e 1.3 16V MultiAir
turbo T270 aplicados nos Fiat Toro
(21>), Fastback (22>) e Pulse Abarth
(22>) e nos Jeep Renegade (22>),
Compass (21>) e Commander (21>)

NOVIDADES

PREÇO DE CUSTO

R\$ 199,99

Alicate desencapador de fios automático



1344051108

LIQUIDANDO R\$ 199,99

(Somente 03 unidades)

Possui batente para controlar e ajustar o tamanho do fio a ser desencapado. Corpo construído em aço carbono com grande durabilidade e pintura contra oxidação.

Lâminas fabricadas em aço sinterizado que garantem maior resistência com dureza entre 52 - 57 HRC.

Cabos com dupla injeção.

Fácil ajuste dos cabos a serem desencapados.

O batente possibilita desencapar sempre um mesmo comprimento de fio que otimiza a operação posterior de crimpagem com terminais normalizados.

Pino de micro ajuste que regula a intensidade da força para corte do fio. Desencapa 7 diferentes bitolas de fios 0,2 à 6,0 mm².

Corta fios de 0,2 à 6,0 mm².

Crimpa 3 diferentes tipos de terminais: com isolamento, sem isolamento de 10 - 22 AWG (0,5 mm² à 6,0 mm²) e de ignição de 7 mm à 8 mm.

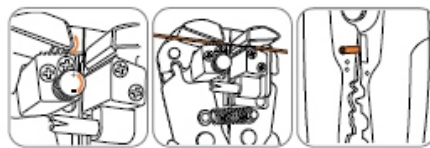

Ao girar o pino no sentido anti horário, menor será a força para desencapar o fio.

Descascador de fios.
Pelo fios | Strip wires.

Corta cabos.
Cut wires.

Al girar el pino en el sentido anti horario, menor será la fuerza para pelar el hilo.

Turning the bolt counterclockwise, less it will be the strength to strip the wire.

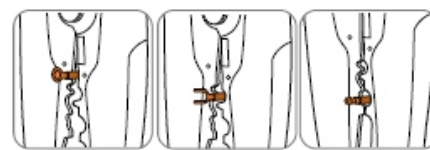

Crimpa terminais com isolamento.

Crimpa terminais sem isolamento.

Crimpa terminais de ignição.

Crimp insulated terminals.

Crimp non-insulated terminals.

Crimp ignition terminals.

NOVIDADES

LANÇAMENTOS

SGT Σ TOOLS
By SIGMA

BALDE LIMPA BOINAS

13SGT-990036



SISTEMA PARA LIMPEZA DE BOINAS

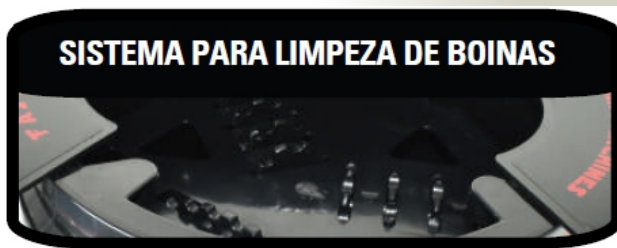

BALDE SEPARADOR DE PARTÍCULAS COM CARRINHO 360°

13SGT-990035



SEPARADOR DE
PARTÍCULAS



COM CINCO
RODÍZIOS



CAPACIDADE

ATÉ
20L

13SGT-990050

KIT 11 ESPATULAS PARA PAINÉIS E PORTAS

CARACTERÍSTICAS

- Espátulas de nylon;
- Largura: de 160mm a 600mm;
- Comprimento: de 160 a 215mm;
- Kit com 11 peças;



NOVIDADES

LANÇAMENTOS

SGT Σ TOOLS
By SIGMA

13SGT-8503

LANTERNA RECARREGÁVEL
DE LED COM DUAS FONTES
DE ILUMINAÇÃO E GIRO **180**
GRAUS.



FÁCIL FIXAÇÃO
COM IMÃ E
GANCHO

COM DUAS FONTES
DE ILUMINAÇÃO E
GIRO 180 GRAUS

LÂMPADA FRONTAL
COM 3 INTENSIDADES
DE LUZ
100% / 50% / 25%

MÁXIMO 800lm
NA LÂMPADA
FRONTAL
3,7V / 1.800mAh

SGT Σ TOOLS
By SIGMA



13990041

PAINEL ORGANIZADOR
DE FERRAMENTAS 18 PEÇAS



SGT Σ TOOLS
By SIGMA



MÁX.
1200
LUMEN



2 BASES
MAGNÉTICAS



TECNOLOGIA
LI-ION



13SGT-8520

LANTERNA DE LED
RECARREGÁVEL PARA CAPÔ
E INTERIOR AUTOMOTIVO

3 EM 1

NOVIDADES

LANÇAMENTOS

SGT Σ TOOLS
By SIGMA



CÓDIGO
13SGT-0539

CHAVE DE IMPACTO
1/2" 200 kgf.m
EXTREMO TORQUE

13MXT-5131

POLITRIZ ROTO ORBITAL 6" – 21MM



1050W

CARACTERÍSTICAS

- Design ergonômico com corpo emborrachado;
- 1050W de potência;
- Cabo com 5m de comprimento;
- 7 níveis de velocidade;
- Duas empunhaduras: frontal e tipo D.

ACESSÓRIOS

- O equipamento vem acompanhado de:
- 1 – Disco velcrado 6" rosca 5/16"-24 fios;
 - 1 – Chave de boca;
 - 1 – Chave allen;
 - 2 – Boínas de espuma 6".

ENGRAXADEIRA PNEUMÁTICA

SGT Σ TOOLS
By SIGMA



CÓDIGO
13SGT-4000

NOVIDADES

LANÇAMENTOS

SGT  **TOOLS**
By SIGMA



13SGT-7510
CHAVE DE IMPACTO 3/4" À BATERIA 1.500NM

- Dispensa uso de compressor;
 - Desenho ergonômico;
 - Regulagem de torque em 3 níveis;
 - Maior autonomia (2 baterias 20V de Lithium-Ion);
- Autonomia de até 200 parafusos (aproximadamente 50 rodas com 4 parafusos);
- Possui botão de reversão para aperto e desaperto.

Aplicações
Indicado para operações de aperto e desaperto de parafusos e porcas em geral, onde há exigência de alto torque.

Aplicações de uso automotivo, montagens e desmontagens.



13SGT-7500

CHAVE DE IMPACTO À BATERIA

- Dispensa uso de compressor;
- Desenho ergonômico;
- Regulagem de torque em 3 níveis;
- Maior autonomia (2 baterias 20V de Lithium-Ion);
- Autonomia de até 200 parafusos (aproximadamente 50 rodas com 4 parafusos);
- Possui botão de reversão para aperto e desaperto.

Acessórios Inclusos

- Maleta;
- 2 Baterias (1 na ferramenta e 1 avulsa);
- 1 carregador rápido (carga em até 2 horas)

13MXT-7505

PARAFUSADEIRA DE IMPACTO 1/4" BRUSHLESS À BATERIA 350NM – 21V/3AH – 2 BATERIAS

Características

- Leve e compacta;
- Anatômica e emborrachada;
- Desenho ergonômico;
- Mandril com propulsor de troca rápida de ponteira;
- Controle de torque ajustável;
- Regulagem de velocidade (alta e baixa).

Aplicações

Utilizada para apertos e desapertos de parafusos em montagens e desmontagens.



NOVIDADES

LANÇAMENTOS

SGT  **TOOLS**
By SIGMA

SOQUETES DE IMPACTO SIGMA

SOQUETES DE IMPACTO 1/2



- 1303121010 SOQUETE CR-MO 1/2" LONGO 10MM
- 1303121011 SOQUETE CR-MO 1/2" LONGO 11MM
- 1303121012 SOQUETE CR-MO 1/2" LONGO 12MM
- 1303121013 SOQUETE CR-MO 1/2" LONGO 13MM
- 1303121014 SOQUETE CR-MO 1/2" LONGO 14MM
- 1303121015 SOQUETE CR-MO 1/2" LONGO 15MM
- 1303121017 SOQUETE CR-MO 1/2" LONGO 17MM
- 1303121019 SOQUETE CR-MO 1/2" LONGO 19MM
- 1303121021 SOQUETE CR-MO 1/2" LONGO 21MM
- 1303121024 SOQUETE CR-MO 1/2" LONGO 24MM



SOQUETE IMPACTO 3/4

- 1303122024 SOQUETE CR-MO 3/4" LONGO 24MM
- 1303122027 SOQUETE CR-MO 3/4" LONGO 27MM
- 1303122029 SOQUETE CR-MO 3/4" LONGO 29MM
- 1303122030 SOQUETE CR-MO 3/4" LONGO 30MM
- 1303122032 SOQUETE CR-MO 3/4" LONGO 32MM
- 1303122033 SOQUETE CR-MO 3/4" LONGO 33MM
- 1303122036 SOQUETE CR-MO 3/4" LONGO 36MM
- 1303122038 SOQUETE CR-MO 3/4" LONGO 38MM
- 1303122041 SOQUETE CR-MO 3/4" LONGO 41MM



SOQUETE IMPACTO 1'

- 1303123022 SOQUETE CR-MO 1" LONGO 22MM
- 1303123024 SOQUETE CR-MO 1" LONGO 24MM
- 1303123027 SOQUETE CR-MO 1" LONGO 27MM
- 1303123030 SOQUETE CR-MO 1" LONGO 30MM
- 1303123032 SOQUETE CR-MO 1" LONGO 32MM
- 1303123033 SOQUETE CR-MO 1" LONGO 33MM
- 1303123036 SOQUETE CR-MO 1" LONGO 36MM
- 1303123038 SOQUETE CR-MO 1" LONGO 38MM
- 1303123041 SOQUETE CR-MO 1" LONGO 41MM
- 1303123046 SOQUETE CR-MO 1" LONGO 46MM

1303141001

JOGO DE SOQUETES CR-MO 1/2" LONGO -
4 PEÇAS (14/17/19/21MM)



1303191000

KIT DE ADAPTADORES
PARA SOQUETES DE IMPACTO - 8 PEÇAS



COMPOSIÇÃO KIT

- | |
|---------------------|
| 1 UND - 1" x 3/4" |
| 1 UND - 3/4" x 1" |
| 1 UND - 3/4" x 1/2" |
| 1 UND - 1/2" x 3/4" |
| 1 UND - 1/2" x 3/8" |
| 1 UND - 3/8" x 1/2" |
| 1 UND - 3/8" x 1/4" |
| 1 UND - 1/4" x 3/8" |

NOVIDADES

LANÇAMENTOS

SGT  TOOLS
By SIGMA

COLETOR DE ÓLEO – 75L COLETOR DE ÓLEO – 30L



1390111

Especificações Técnicas • Peso: 8kg;

- Capacidade de: 20 ou 75 litros;
- Dimensões do reservatório: Ø45cm;
- Altura com rodas: 73cm;
- Altura máxima dos tubos: 50cm cada;
- Diâmetro dos tubos externo: Ø46 menor e Ø49 maior;

FUNIL DE ÓLEO AUTO AJUSTAVEL UNIVERSAL



1302562



1390110

Especificações Técnicas • Peso: 4,2kg;

- Capacidade de: 30 litros;
- Dimensões do reservatório: Ø45cm;
- Altura com rodas: 40cm;
- Altura máxima dos tubos: 50cm cada;
- Diâmetro dos tubos externo: Ø46 menor e Ø49 maior;

MEDIDOR DE PROFUNDIDADE DO PNEUS



135123



NOVIDADES

LANÇAMENTOS



13SGT-9900 00
CARRO ESTEIRA PARA MECÂNICO COM ENCOSTO
CAPACIDADE 150KG

Jogo de soquetes estriados 1/2
22 peças



Jogo de soquetes sextavados 1/2"
11 peças

Perfeito para profissionais liberais e hobbistas que curtem realizar reparos e consertos em seu veículo, seja ele carro ou Amplo mix de soquetes, chaves e acessórios, nos diversos perfis e principais encaixes, que não pode faltar na manutenção do seu veículo.

O Jogo 5000R é praticamente uma oficina móvel!

- Composição:
- 6 Bits hexagonais 10mm (H5, H6, H7, H8, H10, H12)
- 3 Bits multidentado 10mm
- 8 Bits hexalobular 10mm
- 1 Adaptador 1/2" - 10mm
- 1 Chave de apoio para haste
- 1 Haste com duas pontas fenda cruzada PH1 e PH2
- 1 Haste com ponta fenda simples 4,6mm
- 1 Haste com ponta fenda simples 5,7mm
- 1 Jogo de chave L hexagonal (H1,5, H2, H2,5, H3, H4, H5, H6, H8, H10)
- 1 Jogo de chave L hexalobular (T10, T15, T20, T25, T27, T30, T40)
- 1 Alicete universal 7"
- 14 Chaves combinadas planas (6, 7, 8, 9, 10, 11, 12, 13, 14, 15, 16, 17, 18, 19mm)
- 14 Soquetes sextavado 1/2" (8, 9, 10, 11, 12, 13, 14, 15, 16, 17, 18, 19, 20, 21, 22)
- 6 Soquetes hexalobular 3/8" (E8, E10, E12, E14, E16, E18)
- 1 Extensão DE 5" - 1/2"
- 1 Chave catraca reversível 10" com botão de troca rápida
- 1 Chave de vela sextavada com borracha 16mm - 1/2"
- 1 Junta universal de 1/2"
- 1 Adaptador de 1/2" para 3/8"



FERRAMENTAS

LIXADEIRA ORBITAL



Base P/. lixadeira
6" 13PB6VC
5" 13PB5VC

13SK71

PNEUMÁTICAS

13SGT-0535

CHAVE DE IMPACTO 1/2" – 125 KGF.M



- Características
- Carcaça em alumínio;
 - Desenho ergonômico;
 - Regulagem de torque em 3 níveis;
 - Botão de reversão do sentido da rotação;
 - Exaustão de ar através pelo cabo;
 - Mecanismo de impacto tipo Twin Hammer

(Martelo Duplo)

Aplicações

Indicado para operações de aperto e desaperto de parafusos e porcas onde seja requerida um equipamento de alto torque

CHAVE IMPACTO PNEUMÁTICA

13SGT-0526



CARACTERÍSTICAS:

Características

- Máquina SUPER CURTA;
- Ferramenta de ótimo torque para trabalhos rápidos em locais de difícil acesso;
- Carcaça em alumínio;
- Desenho ergonômico;
- Regulagem de torque em 3 níveis;
- Botão de reversão do sentido da rotação;
- Exaustão de ar através do cabo;
- Mecanismo de impacto tipo Jumbo Hammer.

13SGT-0529

1/2"
82 kgf.m
Twin Hammer



DISCO CORTE AÇO/ INOX

DISCO BOSCH INOX 4.1/2X1.0X 7/8



05DC412SC



05DC7SC

BOINA DUPLA FACE LÃ 8' ROSCA 5/8



MACIA
238001

AGRESSIVA
238003

INTERFACE HOOKIT6' (LIXADEIRA ORBITAL)

(Usado entre disco e a lixa)



139006

Soquete de impacto sextavado longo encaixe 1/2"
Afrouxar e apertar parafusos sextavados em rodas de liga leve utilizando parafusadeiras pneumáticas



17 mm
1344889117

19 mm
1344889119

21 mm
1344889121

FERRAMENTAS

MANUAIS

SUPORE MAGNÉTICO PARA CHAVES DE IMPACTO



SUPORE MAGNÉTICO PARA CHAVES DE IMPACTO
COD.: 0689990026



13SGT-990026



13SGT-990050 KIT 11 ESPATULAS PARA PAINÉIS E PORTAS

CARACTERÍSTICAS

- Espátulas de nylon;
- Largura: de 160mm a 600mm;
- Comprimento: de 160 a 215mm;
- Kit com 11 peças;

JOGO DE CHAVE COMBINADA EM SUPORE COM 8 PEÇAS (8-19MM)



131208MRS01

CHAVE BIELA TRAMONTINA MASTER/GEDORE RED

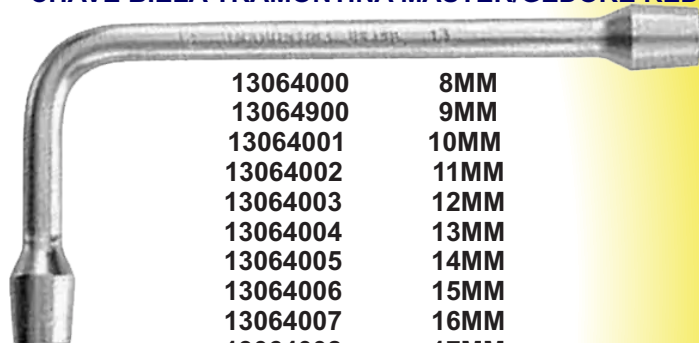

13064000	8MM
13064900	9MM
13064001	10MM
13064002	11MM
13064003	12MM
13064004	13MM
13064005	14MM
13064006	15MM
13064007	16MM
13064008	17MM
13064009	18MM
13064010	19MM

CANETA TESTE POLARIDADE



13KA076

caneta teste polaridade
com voltímetro 12/24 Volts

Chave biela tipo torx E (Femea)

- 1344735106 E6
- 1344735108 E8
- 1344735110 E10
- 1344735112 E12
- 1344735114 E14
- 1344735118 E18
- 1344735120 E20
- 1344735124 E24

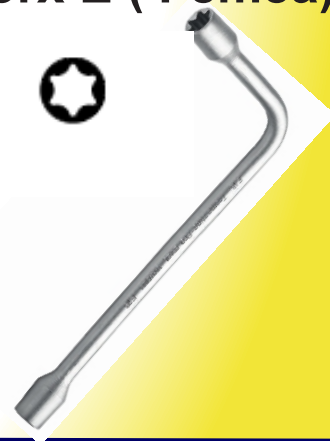

TORNO DE BANCADA (MORSA) NOLL



LIQUIDANDO

Referência	Abertura (mm)	Mordente (mm)	Código
Nº 3	75	85	13TB03
Nº 5	115	135	13TB05
Nº 8	175	200	13TB08

NOVIDADES

GEDORE red



13067005 CHAVE COMBINADA 10MM GEDORE RED
13067007 CHAVE COMBINADA 12MM GEDORE RED
13067010 CHAVE COMBINADA 15MM GEDORE RED
13067016 CHAVE COMBINADA 21MM GEDORE RED



1315004 JOGO CHAVES FENDA P/M/G
DGEDORE RED 03 FENDAS E 02 PHILIPS



131501 CHAVE FENDA 5MMX125MM (3/16X4) gedore RED
131503 CHAVE FENDA 6,5MMX150MM (1/4X6) gedore RED
131505 CHAVE FENDA 8X200MM (5/16X8) gedore RED



131600 CHAVE PHILIPS 3X125MM(1/8X4#) gedore RED
131601 CHAVE PHILIPS 5MMX100MM (3/16X4) gedore RED
131603 CHAVE PHILIPS 6X150 (1/4X6#) gedore RED
131604 CHAVE PHILIPS 8X150MM (5/16X6#) gedore RED



13062080 ALICATE UNIVERSAL 8 POL.SIMPLES



13670 ALICATE BICO RETO 6 1/2



13680 ALICATE CORTE 6" POL

NOVIDADES

13 SGT-9001

CARRETEL ENROLADOR MANGUEIRA DE AR COMPRIMIDO EM PU



MANGUEIRA PARA TRANSFERÊNCIA DE LÍQUIDOS



1333020

MANGUEIRA ESPIRAL PU
8X12 (5/16") - 15M



SIGMA Σ TOOLS

13SA1012

KITEST
EQUIPAMENTOS AUTOMOTIVOS

13TP-016.P.MERV



TAMPA PARASANGRADOR FREIOS 90°
DA LINHA GM MERIVA E
PEUGEOT 2008-3008
PARA USO NO SANGRADOR
16KA023

LANÇAMENTOS

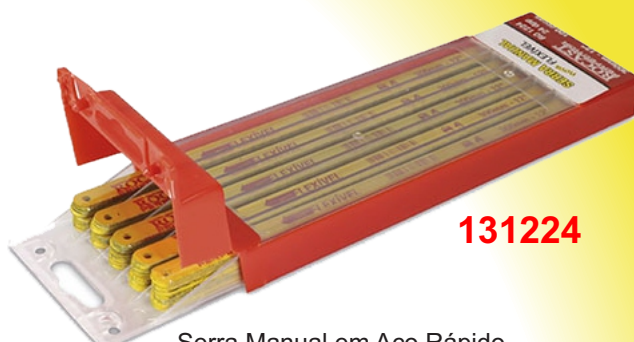

131224

Serra Manual em Aço Rápido
Aplicação: aços em geral / construção civil.
Vendas em quantidade múltiplas de 10 unidades.
Comprimento Serra x Quantidade DentesPeças por Embalagem
12" x 24 dentes100

Indicada para transferência de líquidos como gasolina, diesel e água, eliminando o uso do funil.
Utilizada para abastecer e transferir combustíveis de carros e motos, abastecer tratores no campo, abastecer barcos na marina, abastecimento de geradores, esvaziar caixa d'água, entre outros.
Proporciona maior segurança, pois o líquido não entra em contato com a pele ou a boca do operador, utilizando a força da gravidade para a sua transferência de um recipiente para outro. Uma válvula de esfera permite a passagem do líquido através de rápidos movimentos verticais (para baixo e para cima) e, uma vez dentro da mangueira, o líquido flui por ação da gravidade.



SIGMA Σ TOOLS

13CAR-10

CARRINHO ERGONÔMICO PARA CHAVE DE IMPACTO 1"
Ferramenta auxiliar à chave de impacto de 1"
na troca de rodas de caminhões e ônibus.

SANGRADOR FREIO



13KA023

PROMOÇÕES



05DC412SC-50

LIQUIDAÇÃO R\$ 99,99

(EMQUANTO DURAR O ESTOQUE)
DISPONÍVEL 16 CAIXAS

DISCO CORTE AÇO/ INOX



13KA01517

Teste de pressão para bomba de combustível para automóveis

Manômetro de aço Inox, glicerina e 17 mangueiras
Foi desenvolvido com a finalidade de auxiliar o reparador a testar a bomba elétrica do veículo

Composição:

Manual de instruções

Manômetro de aço inox 12 Bar / 170 PSI

Jogo de mangueiras contendo 17 mangueiras
(sendo duas no corpo do manômetro)



PULVERIZADOR MANUAL ORANGE 2L 13SGT-9925

APLICAÇÕES
Pulverização de líquidos não corrosivos em aplicações automotivas, jardinagem e outros usos profissionais e hobbistas.



PISTOLA DE SOLDA



28W 220V - 60Hz

13VD230

13IJ-2154



OSCILOSCÓPIO 8 CANAIS

13107705

Cavelete telescópico (1,40 a 2,00 m) para apoiar escapamentos, suspensões e tanques de combustível. As rodas facilitam a movimentação na oficina e um rolamento na rosca diminui o esforço do operador. Sugestão: a bandeja 102555, vendida separadamente, pode ser usada sobre o 107705 para coletar óleo.

Peso: 10,8 Kg

Raven
Ferramentas Especiais



PROMOÇÕES



Carregador Inteligente de Bateria F10



Potência real: 10 A = 120 W
 Sistema de flutuação: 14 V
 Tensão de entrada: Bivolt 127/220V
 Corrente de entrada 127 V: 2 A
 Corrente de entrada 220 V: 1,5 A
 Corrente de saída: 1-10 A/H AUTOMÁTICO
 Frequência: 60Hz

13CB10



Teste de bateria analógico.

Escala de: 0 a 16V.
 Capacidade até: 125 A.
 Teste de carga da bateria.
 Teste do regulador de voltagem.
 Teste de alternador.

13DM-090

Carregador Inteligente de Bateria F150 RNEW

Descrição do produto

F 150 RNEW 12V/24V

Potência real: 60A = 720W

Potência real 24V: 60A = 1440W

Sistema de flutuação: 14V/28V

Tensão de entrada: bivolt 127/220V

Corrente de saída: 1 - 60 A/H AUTOMÁTICO

Tamanho: A: 56cm - L: 27cm - C: 43cm

Seleção automática de carga quando

conectado em 12V ou 24V

Amperímetro digital

Sistema de alca retrátil

Carrinho de transporte

Auxilia a bateria na partida com até 150 A

Transformador envernizado

Caixa galvanizada com pintura eletrostática

Baterias acima de 1,5 volts, recarga 12 volts

Baterias acima de 18 volts, recarga 24 volts

Proteção contra sobrecargas na saída

e ligação invertida

Refrigeração Forçada

Sistema automático de reativação

de baterias

Cooler para refrigeração

Carga inteligente (somente a

necessidade da bateria)

Carrega qualquer tamanho de bateria

2 (dois) anos de garantia

Projeto exclusivo

12/24 volts



CÓDIGO
13CB150T

Testador de Baterias Flach

RECURSOS E FUNÇÕES DO TESTADOR TBF-2000:

- Tensão do sistema: 12 Volts.
- Resultado do teste: bom, recarregar ou substituir.
- Capacidade: informações de CCA, DIN, EN e IEC de no máximo 2000A.
- Valor da resistência interna da bateria (mΩ).
- Vida útil da bateria em porcentagem (%).
- Teste de bateria (dentro e fora do carro) e outras funções adicionais.
- Teste do sistema de capacidade de partida.
- Teste do sistema de carga.
- Teste de oscilação do alternador em formato de onda.
- Registre e reproduza os resultados dos testes (serviço de atualização vitalício e gratuito).
- Sistema de voltagem: 12 volts
- Alcance de tensão de entrada: 8v~16v
- Requisitos de energia: Não necessita de baterias internas;
- Liga quando conectado à bateriam durante o teste.



13TBF2000

LANTERNA DE CABEÇA RECARREGÁVEL LED



13SGT-8510

POTÊNCIA 5W
 FLUXO LUMINOSO (LUMENS) 150LM
 LÂMPADA LED BULB XPE
 BATERIA 3,7V / 2AH
 CARREGADOR USB
 AUTONOMIA 5 HORAS
 TEMPO DE CARREGAMENTO 6 HORAS

FIXAÇÃO ELÁSTICO AJUSTÁVEL
 PROVA D'ÁGUA IPX4
 DIMENSÕES 80MM
 PESO 0,070 KG

LANTERNA LED COB RECARREGAVEL 10W - 300LM



13SGT-8501

LUMINARIA DE LED



(13TLT400 110/200V PLUG)
 (13TLT02 12V GARRA)
 (13TLT516 220V MINI)

PROMOÇÕES

LANÇAMENTOS

MULTÍMETRO DIGITAL PROFISSIONAL
COM CAPACIMETRO –
13DT9205A



Câmera filmadora para
celular tablet e Pc



13DM-230
Endoscopia automotiva

SACA FILTROS JEEP E FIAT
13KF256



LINHA JEEP E FIAT TORO
MOTORES TURBO FLEX 1.3



13KF257



LINHA JEEP E FIAT TORO
MOTORES TURBO DIESEL 2.0

PROMOÇÕES



13TLT60
PENDETES DE LED HÍBRIDO

R\$ 99,99

(Disponível 10 unidades)

- 30 LEDs
- Mais fino
- Alta resistência
- Cabo de alimentação de 5 metros
- 1.500 Lúmens



LUMINARIA DE LED



13TLT400 110/200V PLUG

13TLT02 12V GARRA

R\$ 79,99

13TLT516 220V MINI

R\$ 89,99

PROMOÇÕES

LANÇAMENTOS



**CONJ. FERR. PARA RETORNAR
ÊMBOLOS DE PINÇAS DE FREIO
TRASEIRAS COMPLETO**

13KF130.KIT-C

**Ferramentas para retorno
da pinça de freios
parcial**

13FE009B

OU

13KF130.KIT



13DT-FRA01

**KIT DE FERRAMENTAS PARA REPARO
EM ALTERNADOR COM 30 PEÇAS**

Permite a remoção fácil da
polia do alternador, dentro ou fora
do veículo;

Kit mais completo do mercado.



05H201

PROMOÇÕES



Caixa com 62 ferramentas organizadas em bandejas plásticas

13902-062MR



Código	Composição	
4335	Soquete sextavado	10, 11, 12, 13, 14, 15, 16, 17, 18, 19, 20, 21, 22, 23, 24, 27, 30, 32
1120	Chaves hexagonal extra longa abaulada	1,5, 2, 2,5, 3, 4, 5, 6, 8, 10
1060	Chaves combinadas	6, 7, 8, 9, 10, 11, 12, 13, 14, 15, 16, 17, 18, 19, 20, 21, 22, 24
1421	Chaves de fenda cruzada	PH1x80, PH2x100, PH3x150
1422	Chaves de fenda simples	5,5x100, 6,5x150, 8x175
6111-07	Alicate universal	7"
6211-06	Alicate de corte	6"
6311-06	Alicate meia-cana	6"
4452FR	Cabo de força articulado 1/2"	18"
4251-10RH 4251-05RH	Extensões 1/2"	5"- 10"
463521RH	Chave de vela sextavada 1/2"	20,8mm
4223-02R	Extensão articulada 15° 1/2"	2"
4572-12RH	Cabo de força T	300mm
4791RH	Junta universal 1/2"	3"
4766-10G	Catraca reversível 1/2"	10"



NOVO LAYOUT CAIXAS FERRAMENTAS 05 e 07 GAVETAS



13CMB100
CAIXA COM 05 GAVETAS
C-50 X L-20CM
PRESTO



6613100
CAIXA COM 07 GAVETAS
50X20CM
PRESTO



1391804
CAIXA COM 07 GAVETAS
50X20 CM PUXADOR E
COM RODINHAS

PROMOÇÕES

TRAMONTINA

Chaves canhão

 **TWISTER**



13336	6 mm
13337	7 mm
13338	8 mm
133310	10 mm
133311	11 mm
133312	12 mm
133313	13 mm
133314	14 mm



Chaves trafix com cabo

 **TWISTER**



1344351015	T15
1344351020	T20
1344351025	T25
1344351027	T27
1344351/030	T30
1344351040	T40
1344351045	T45



Calibre para vela de ignição 1346005000



Calibre de inspeção para pastilhas de freio 1344061102



Alicate de Pressão Mordente curvo

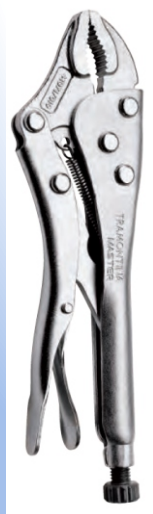

1344014110

Mordentes forjados em aço especial e temperados.
Corpo formado por chapas conformadas.
Acabamento cromado.
Abertura regulável.
Possui alavanca para destravar.

Alicate Bomba-d'Água 10'



13062010

Corpo forjado em aço especial e temperado.
Acabamento fosfatizado.
Têmpera especial nas mandíbulas.
Isolação elétrica de 1.000 V C.A.
Possui 4 regulagens de abertura.

Alicate de Pressão Mordente reto



1344013110

Mordentes forjados em aço especial e temperados.
Corpo formado por chapas conformadas.
Acabamento cromado.
Abertura regulável.
Possui alavanca para destravar.

PROMOÇÕES

TRAMONTINA

SOQUETE XTRACTOR PLUS



1344851108 SOQUETE XTRACTOR PLUS 8MM

1344851109 SOQUETE XTRACTOR PLUS 9MM

1344851110 SOQUETE XTRACTOR PLUS 10MM

1344851111 SOQUETE XTRACTOR PLUS 11MM

1344851112 SOQUETE XTRACTOR PLUS 12MM

1344851113 SOQUETE XTRACTOR PLUS 13MM

1344851114 SOQUETE XTRACTOR PLUS 14MM

1344851115 SOQUETE XTRACTOR PLUS 15MM

1344851116 SOQUETE XTRACTOR PLUS 16MM

1344851117 SOQUETE XTRACTOR PLUS 17MM

1344851118 SOQUETE XTRACTOR PLUS 18MM

1344851119 SOQUETE XTRACTOR PLUS 19MM



Caixa Sanfonedada Cargobox com Rodas e Puxador 5 Gavetas Tramontina PRO



1344952600

R\$ 299,99

TRAMONTINA



PROMOÇÕES

TRAMONTINA

CAIXA CARGO BOX COM FERRAMENTAS 65 PEÇAS TRAMONTINA PRO

**R\$ Bota fora
1499,99**

1344952665

- 
- 
- Soquete Estriado em Aço Cromo Vanádio 6-32 mm - Encaixe 1/2" Tramontina PRO
 - Martelo de bola 500 g C:35.5cm L:3.4cm A:10.9cm
 - Martelo de pena 300 g C:30cm L:2.3cm A:10.5cm
 - Martelo de borda 40 mm
 - Alicate Universal Isolado 1.000 V 8" Tramontina PRO
 - Alicate Corte Diagonal Isolado 1.000 V 6" Tramontina PRO
 - Alicate de Pressão Mordente Triangular 10" Tramontina PRO
 - Chave ajustável 10"
 - Chave de fenda ponta chata 3x75 mm (1/8x3")
 - Chave de fenda ponta chata 5x100 mm (3/16x4")
 - Chave de fenda ponta chata 6x125mm (1/4x5")
 - Chave de fenda ponta chata 8x150 mm (5/16x6")
 - Chave de fenda ponta chata 10x150 mm (3/8x6")
 - Chave de fenda toco ponta chata 6x38 mm (1/4x1.1/2")
 - Chave de fenda ponta cruzada 3x75 mm (1/8x3")
 - Chave de fenda ponta cruzada 5x100 mm (3/16x4")
 - Chave de fenda ponta cruzada 6x150 mm (1/4x6")
 - Chave de fenda ponta cruzada 8x150 mm (5/16x6")
 - Chave de fenda toco ponta cruzada 6x38 mm (1/4x1.1/2")
 - Chave canhão 6 mm
 - Chave canhão 8 mm
 - Chave hexagonal 1 A 10 mm
 - Chave Combinada 6 A 22 mm Tramontina PRO
 - Extensão 5" em Aço Cromo Vanádio - Encaixe 1/2"
 - Extensão 10" em Aço Cromo Vanádio - Encaixe 1/2"
 - Cabo Articulado 10" em Aço Cromo Vanádio - Encaixe 1/2"
 - Junta Universal em Aço Cromo Vanádio - Encaixe 1/2"
 - Catraca 1/2" 10"
 - Cabo T em Aço Cromo Vanádio 10" - Encaixe 1/2"

CAIXA SANFONADA PARA FERRAMENTAS TRAMONTINA COM 5 GAVETAS E ALÇAS FIXAS 60 FERRAMENTAS MASTER 1343800945

Torra/torra

R\$ 999,99

SOMENTE 03 UNIDADES NESTE PREÇO

1343800945

3/16x6 1/4x4 1/4x6

3/16x4 3/16/6 1/4x4

6 á 19 mm

8 á 19 mm

8 á 32 mm

T 10

5' e 10'

LIQUIDAÇÃO

SALDO DE ESTOQUE

Liquidando
R\$ 24,99



13EPP4143
TÁMANHO M



13EPP4142
TÁMANHO GG

EXCELENTE RESISTÊNCIA A CORTE
NOS TRABALHOS PESADOS
INDICADA PARA:

- Indústria automobilística
- Indústria de construção civil
- Indústria metalmecânica
- Manutenção industrial
- Manuseio de peças cortantes
- Manuseio de peças oleosas

SUIÇA TECH

SWISSINT
INTRACE AG

LIQUIDA
SALDÃO

REFIL PARA PALHETA

33163610	Refil Palheta Convencional Par 24 Polegadas Par	R\$ 19,99
33163750	Refil Palheta Convencional Par 30 Polegadas Par	R\$ 89,99
331AT800	Refil Palheta Aerotwin Par 31,5 Polegadas Par	R\$ 29,99
331AT800SP	Refil Palheta Aerotwin Par 31,5 Polegadas Par	R\$ 49,99
331ATDY700	Refil Palheta Slim Blade Dyna Par 27,5 polegadas Par	R\$ 19,99
331HY750	Refil Palheta Híbrida Par 30 Polegadas Par	R\$ 19,99
331AS420	Refil Palheta Traseira Sistema Asiático 16,5" Und.	R\$ 9,99
33163510	Refil Palheta Convencional Tras. 20 Polegadas Und.	R\$ 9,99

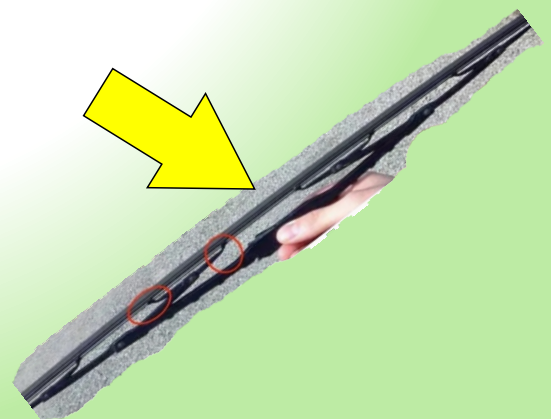
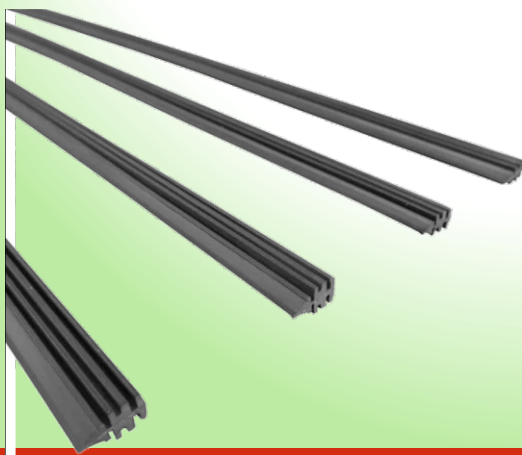

LIQUIDAÇÃO

SALDO DE ESTOQUE NOLL

Jogo de Ferramentas Noll 110 Peças

133640001



R\$ 499,99

(01 unidades)



R\$ 8,99

66131612

(05 unidades)



66131604

5/16x8

(20 unidades)

R\$ 12,99



DISPENSADOR DE PAPEL SIMPLES

6 peças

LIQUIDA

SALDO DE ESTOQUE

CARRO TRANSPORTE DE PNEUS



1 peça

13TA-09

DISPENCADOR DE PAPEL CARRINHO



1 peça

13DP3

LUMINÁRIA 70 LEDS SMD RECAREGAVEL 127/220V OU 12V



13TLT80N LUMINÁRIAS 70 LEDs

13TLT516

LUMINÁRIA 12 LEDS-CURTA 110-220 VOLTS CABO 5METROS

LUMINÁRIAS LED



LIQUIDA

SALDO DE ESTOQUE



05H202

ÁGUA DESTILADA 200 ML
CAIXA COM 48 FRASCOS
(PARA USO EM BATERIAS E RADIADORES AUTOMOTIVOS)
R\$ 0,49 O FRASCO
(NA CAIXA C/. 48 UNIDADES)

ÁLCOOL GEL 70%

